

SONY[®] SERVICE MANUAL

RA-3 CHASSIS

<u>MODEL</u>	<u>COMMANDER</u>	<u>DEST.</u>	<u>CHASSIS NO.</u>	<u>MODEL</u>	<u>COMMANDER</u>	<u>DEST.</u>	<u>CHASSIS NO.</u>
KP-48V80	RM-Y906	US	SCC-P14CA	KP-61V80	RM-Y906	US	SCC-P14BA
KP-48V80	RM-Y906	Canadian	SCC-P14CA	KP-61V80	RM-Y906	Canadian	SCC-P14BA
KP-53V80	RM-Y906	US	SCC-P14AA				
KP-53V80	RM-Y906	Canadian	SCC-P14AA				

CORRECTION -1

Subject : Correction of Set-up adjustments

File this correction with the service manual.

TABLE OF CONTENTS

<u>Section</u>	<u>Title</u>	<u>Page</u>
3.	SET-UP ADJUSTMENTS	
3-1.	Screen Voltage Adjustment (Coarse Adjustment)	2
3-2.	Screen (G2) Adjustment (Fine Adjustment)	2
3-3.	Deflection York Tilt Adjustment	2
3-4.	Focus Lens Adjustment	2
3-5.	Focus VR Adjustment	3
3-6.	2-Pole Magnet Adjustment (Green, Red)	3
3-7.	4-Pole Magnet Adjustment	3
3-8.	Defocus Adjustment (Blue)	3
3-9.	Electrical Adjustment by Remote Commander	4
3-10.	Registration Adjustment (PJE)	9
3-11.	Auto Registration Error Code List	12

※ Please file according to model size.

48

53

61

SECTION 3 SET-UP ADJUSTMENTS

3-1. SCREEN VOLTAGE ADJUSTMENT (COARSE ADJUSTMENT)

1. Receive the Monoscope signal.
2. Set 50% BRIGHTNESS and minimum PICTURE.
3. Turn the red VR on the FOCUS block all the way to the left and then gradually turn it to the right until the point where you can see the retrace line.
4. Next gradually turn it to the left to the position where the retrace line disappears.

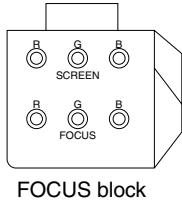

Fig. 3-1

3-2. SCREEN (G2) ADJUSTMENT (FINE ADJUSTMENT)

Fine Mode is recommended to set screen controls to their optimal condition. It is necessary to build the simple jig, illustrated below, using 3-watt resistors. Please note, that if the proper voltage is not obtained with their listed values, resistors, then please increase or decrease one of the values in the resistor network to obtain the correct voltage.

1. Select VIDEO1 mode without signals.
2. Connect G2 JIG.
3. SW on JIG.
4. Connect an oscilloscope to the TP701(KR), TP732(KG) and TP761(KB) of CR board, CG board and CB board.
5. Adjust R, G and B screen voltage to 170-173V with screen VR on the Focus block.

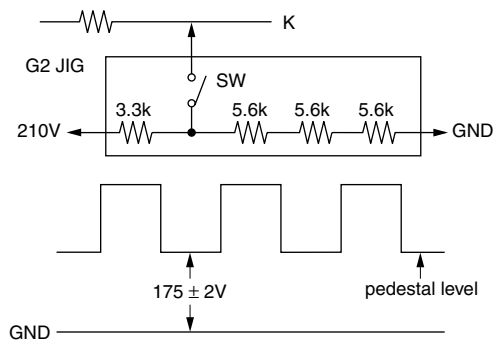

Fig. 3-2

3-3. DEFLECTION YOKE TILT ADJUSTMENT

1. Receive the Monoscope signal.
2. Set in service mode.
3. Cover the both red and blue picture lenses with the lens caps to show only the green color.
4. Loosen the deflection yoke set screw and align the tilt of the Deflection Yoke so that the bars at the center of the monoscope pattern are horizontal.
5. After aligning the deflection yoke, fasten it securely to the funnel-shaped portion (neck) of the CRT.
6. The tilt of the deflection yoke for red is aligned in the mode Cover the both green and blue picture lenses with the lens caps and the tilt of the deflection yoke for blue is aligned with in

the mode Cover the both green and red picture lenses with the lens caps is aligned the same as was done for green.

Note: Instead of items 3 and 6, you can cut off the unnecessary color beams by controlling the service mode VPNT 28 RON, 29 GON, and 30 BON.

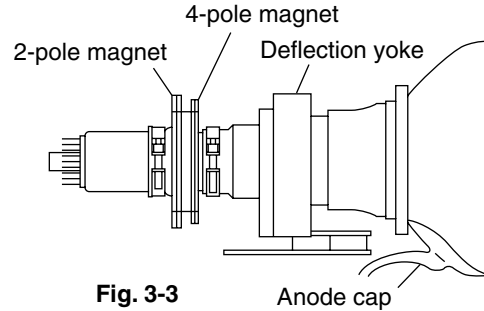

Fig. 3-3

3-4. FOCUS LENS ADJUSTMENT

In this adjustment, use the remote commander in the service mode.

For details of the usage of the service mode and the remote commander, please refer the item 3-9. ELECTRICAL ADJUSTMENT BY REMOTE COMMANDER.

1. Loosen the lens screw.
2. Set to the service mode.
3. Receive the all-white signal.
4. Cover the both red and blue picture lenses with the lens caps to show only the green color.
5. Set to PJE, and press 6 to display the test signal (crosshatch)** on the screen.
6. Turn the green lens to adjust to the optimum focus point with the test signal.
7. Tighten the lens screw.
8. Cover the both green and blue picture lenses with the lens caps to show only the red color.
9. Set to PJE, and press 6 to display the test signal (crosshatch)** on the screen.
10. Adjust red CRT lens just the same as green.
11. Cover the both green and red picture lenses with the lens caps to show only the blue color.

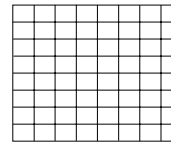

Test signal

Fig. 3-4

12. Set to PJE, and press 6 to display the test signal (crosshatch)** on the screen.
13. Adjust blue CRT lens just the same as green.
14. After adjusting the items 3-5. Focus VR Adjustment, 3-6. 2-Pole Magnet Adjustment and 3-7. 4-Pole Magnet Adjustment, adjust again to the optimum focus point.

*: Every time you press 6, the test signal changes to "crosshatch+video signal" - "dots+video signal" - "crosshatch(black)" - "dots(black)" - off.

Note: Instead of items 4, 8 and 11, you can cut off the unnecessary color beams by controlling the service mode VPNT 28 RON, 29 GON, and 30 BON.

3-5. FOCUS VR ADJUSTMENT

1. Set to the service mode.
2. Receive the all-white signal.
3. Cover the both red and blue picture lenses with the lens caps to show only the green color.
4. Set to PJE, and press 6 to display the test signal (crosshatch) on the screen.
5. Turn the green focus VR on the focus block to adjust to the optimum focus point with the test signal.
6. Cover the both green and blue picture lenses with the lens caps to show only the red color.
7. Set to PJE, and press 6 to display the test signal (crosshatch) on the screen.
8. Turn the red focus VR on the focus block to adjust to the optimum focus point with the test signal.
9. Cover the both green and red picture lenses with the lens caps to show only the blue color.
10. Set to PJE, and press 6 to display the test signal (crosshatch) on the screen.
11. Turn the blue focus VR on the focus block to adjust to the optimum focus point with the test signal.
12. After adjusting the items 3-4. Focus Lens Adjustment, 3-6. 2-Pole Magnet Adjustment and 3-7. 4-Pole Magnet Adjustment, adjust again to the optimum focus point.

Note: Instead of items 3, 6 and 9, you can cut off the unnecessary color beams by controlling the service mode VPNT 28 RON, 29 GON, and 30 BON.

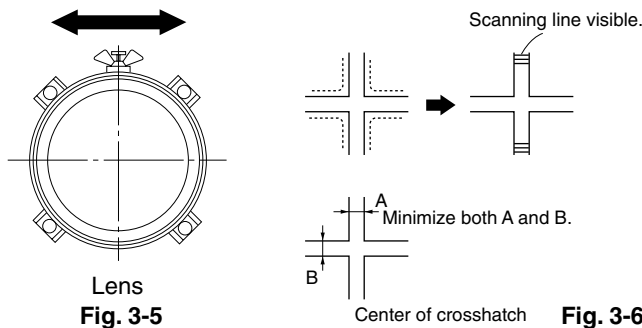

3-6. 2-POLE MAGNET ADJUSTMENT (GREEN, RED)

1. Receive the Dot signal.
2. Set in service mode.
3. Cover the both red and blue picture lenses with the lens caps to show only the green color.
4. Turn the green focus VR on the focus block to the right and set to overfocus to enlarge the spot.
5. Now align the 2-Pole Magnet so that the enlarged spot is in the center of the Just Focus spot.
6. Align the green focus VR and set for just (precise) focus.
7. Perform the same alignment for red.

Use the center dot

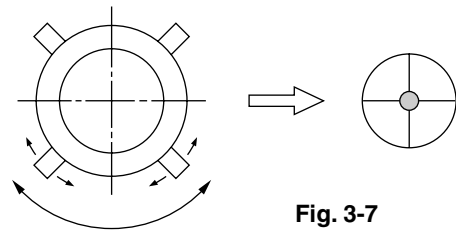

3-7. 4-POLE MAGNET ADJUSTMENT

1. Receive the Dot signal.
2. Set in service mode.
3. Cover the both red and blue picture lenses with the lens caps to show only the green color.
4. Turn the green focus VR on the focus block to the left and set to underfocus to enlarge the spot.
5. Now align the 4-Pole Magnet so that the enlarged spot becomes a perfect circle for green and red.
6. Perform the same alignment for blue.

Use the center dot

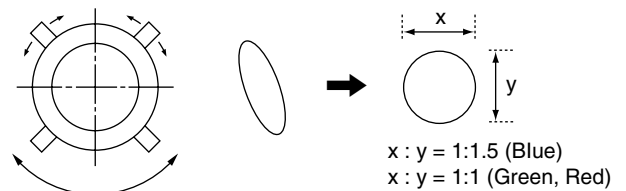

3-8. DEFOCUS ADJUSTMENT (BLUE)

Note: Please adjust the blue dot to be slightly larger than red and green dots. This adjustment provides a more pleasing picture to the customer.

1. Select the video menu and set the mode to "VIVID" mode.
2. Set to the service mode.
3. Change TV mode to the video input mode.
4. Set to PJE, and press 6 to display the test signal (dots) on the screen.
5. Turn the blue focus VR on the focus block to adjust to the diameter of the dots as shown in the figure below.

[Focus adjustment point]

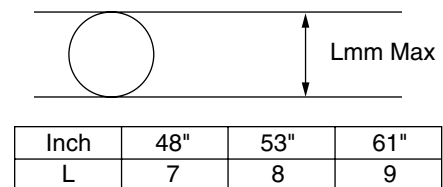

3-9. ELECTRICAL ADJUSTMENT BY REMOTE COMMANDER

By using Remote Commander (RM-Y902), all circuit adjustments can be made.

NOTE : Test Equipment Required.

1. Pattern Generator (with component outputs)
2. Frequency counter
3. Digital multimeter
4. Audio oscillator

1. METHOD OF SETTING THE SERVICE ADJUSTMENT MODE

SERVICE MODE PROCEDURE

1. Standby mode. (Power off)
2. **DISPLAY** → **5** → **VOL (+)** → **TV POWER** on the Remote Commander.
(Press each button within a second.)

SERVICE MODE ADJUSTMENT

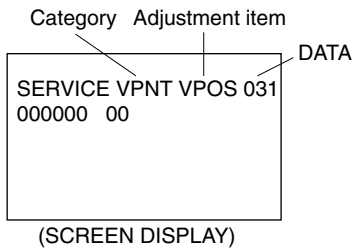

3. The SCREEN displays the item being adjusted.
4. Press **1** or **4** on the Remote Commander to select the adjustment item.
5. Press **3** or **6** on the Remote Commander to change the data.
6. Press **2** or **5** on the Remote Commander to select the category.

Every time you press 2(Category up), Service mode changes in the order as shown below.

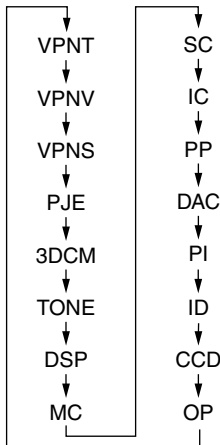

7. If you want to recover the latest values press **0** then **ENTER** to read the memory.
8. Press **MUTING** then **ENTER** to write into memory.
9. Turn power off.

Note: Press **8** then **ENTER** on the Remote Commander to initialize or turn set off and on to exit.

2. MEMORY WRITE CONFIRMATION METHOD

1. After adjustment, remove the plug from AC outlet, and then replace the plug in AC outlet again.
2. Turn the power switch ON and set to Service Mode.
3. Call the adjusted items again and confirm they were adjusted.

3. ADJUSTING BUTTONS AND INDICATOR

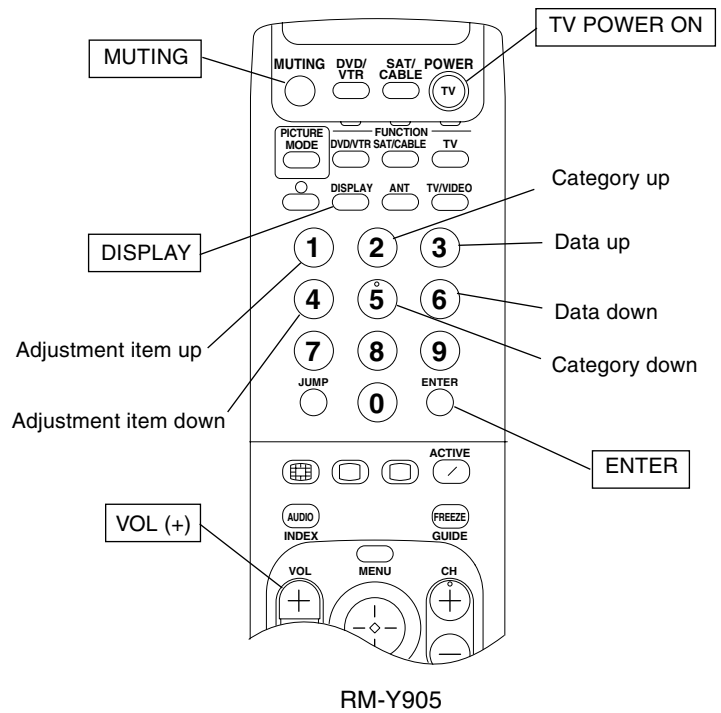

Note : When the PJE mode is activated, which displays an internally generated signal, several buttons on the remote commander will have different functions than listed above. Therefore, when in the PJE mode, refer to page 9 for button functions.

4. SERVICE MODE LIST

Note: • shaded items are fixed. There is no need to change data. Others are different a little in the sets individually. Basically, there is no need to change data, too.
 • Usually, there is no need to adjust except for VPNT and PJE. Use data as a reference in case of replacing printed circuit boards or devices.

VPNT (Video Processor NTSC)

ITEM NUMBER	ADJUSTMENT ITEM	DATA RANGE	STANDARD DATA	NOTE
0	VPOS	0-63	31	V POSITION
1	VSIZ	0-63	31	V SIZE
2	VCOM	0-3	0	V COMP
3	VLIN	0-15	7	V LINEARITY
4	VSCO	0-15	7	V SCURVE CORRECTION
5	HPOS	0-15	7	H POSITION
6	HSIZ	0-63	31	H SIZE
7	PAMP	0-63	31	PIN AMP
8	UPIN	0-15	7	UPPER CORNER PIN DISTORTION
9	LPIN	0-15	7	LOWER CORNER PIN DISTORTION
10	PPHA	0-15	5	PIN PHASE
11	AFC	0-3	2	AFC LOOP GAIN
12	VBOW	0-15	7	V BOW
13	VANG	0-15	7	V ANGLE
14	REF	0-3	3	REFERENCE PULSE POSITION
15	RDRV	0-63	31	RED DRIVE GAIN
16	BDRV	0-63	31	BLUE DRIVE GAIN
17	RCUT	0-15	7	RED CUTOFF
18	BCUT	0-15	7	BLUE CUTOFF
19	SCON	0-15	7	SUB CONTRAST
20	SHUE	0-15	7	SUB HUE
21	SCOL	0-15	7	SUB COLOR
22	CDM2	0,1	0	COUNT DOWN MODE2
23	DPX	0,1	1	DYNAMIC PICTURE
24	NOTC	0,1	0	Y CHROMA TRAP
25	CROM	0-15	7	CHROMA TRAP F0
26	TOT	0,1	0	CHROMA TOT FILTER
27	SHPF	0-3	3	SHARPNESS F0
28	RON	0,1	1	RED ON
29	GON	0,1	1	GREEN ON
30	BON	0,1	1	BLUE ON
31	DCOL	0,1	1	DYNAMIC COLOR
32	CDMD	0,1	0	V COUNT DOWN
33	LBLK	0-15	13	LEFT-SIDE BLANK WIDTH
34	RBLK	0-15	13	RIGHT-SIDE BLANK WIDTH
35	PREC	0-3	1	PRE OVER LEVEL FOR COMP .V IN
36	PREY	0-3	1	PRE OVER LEVEL FOR Y IN

VPNV (Video Processor NTSC Vivid)

ITEM NUMBER	ADJUSTMENT ITEM	DATA RANGE	STANDARD DATA	NOTE
0	SBRV	0-63	27	SUB BRIGHTNESS FOR VIVID
1	GMMV	0-3	2	GAMMA LEVEL FOR VIVID
2	YDCV	0,1	1	Y-DC TRANSFER RATIO FOR VIVID
3	ABLX	0,1	1	ABL MODE FOR VIVID
4	AXIV	0,1	0	AXIS R-Y,G-Y FOR VIVID

VPNS (Video Processor NTSC Standard)

ITEM NUMBER	ADJUSTMENT ITEM	DATA RANGE	STANDARD DATA	NOTE
0	SBRX	0-63	27	SUB BRIGHTNESS FOR STANDARD
1	GMMX	0-3	2	GAMMA LEVEL FOR STANDARD
2	YDCX	0,1	0	Y-DC TRANSFER RATIO FOR STANDARD
3	ABLX	0,1	1	ABL MODE FOR STANDARD
4	AXIX	0,1	0	AXIS R-Y,G-Y FOR STANDARD

3DCM (3D Comb Filter)

ITEM NUMBER	ADJUSTMENT ITEM	DATA RANGE	STANDARD DATA	NOTE
0	NRMD	0-3	0	NOISE REDUCER MODE
1	DYCO	0-15	2	ΔY CORING LEVEL SETTING
2	DYGA	0-15	10	ΔY GAIN SETTING
3	DCCO	0-15	5	ΔC CORING LEVEL SETTING
4	DCGA	0-15	5	ΔC GAIN SETTING
5	SELD	0.1	1	SELECT ΔY SIGNAL FILTER
6	D2GA	0-7	4	ΔY/C 2nd GAIN SETTING
7	VTRH	0-3	1	VTR HSYNC HYSTERESIS SETTING
8	VTRR	0-3	1	VTR HSYNC REFERENCE SETTING
9	LDSR	0-3	2	LD SIGNAL REFERENCE
10	VAPG	0-7	5	V APERTURE GAIN
11	VAPI	0-31	11	V APERTURE INVERT POINT
12	YPFT	0-3	0	Y PEAKING FILTER TAP
13	YPPG	0-15	9	Y PEAKING FILTER GAIN
14	VIPS	0-3	2	VERTICAL 1-LINE SELECTOR
15	VEGS	0-3	1	VERTICAL EDGE SELECTOR
16	CC3N	0.1	0	C SIGNAL 3-LINE COM FILTER
17	HDP	0-7	4	HD HORIZONTAL PHASE
18	CDL	0-7	4	C DELAY
19	HSSL	0-15	12	H SYNC SLICE LEVEL
20	VSSL	0-15	8	V SYNC SLICE LEVEL
21	HPLF	0.1	1	H PLL FILTER
22	BPLF	0.1	0	BURST PLL FILTER
23	FSCF	0.1	1	FSC FILTER GAIN
24	PLFG	0.1	1	PLL FILTER GAIN
25	EXAD	0.1	1	EXTERNAL AD IN
26	MSS	0.1	0	FORCED MOTION SIGNAL
27	COUT	0-3	2	C SIGNAL OUTPUT
28	YAPS	0-3	1	Y APERTURE
29	NSDS	0-3	0	NON STD SIGNAL DETECT.
30	CPP	0-3	0	CLAMP PULSE & AD RANGE
31	YHCO	0-3	1	Y HIGH FREQ.SIGNAL CORING
32	YPCO	0.1	0	Y PEAK FILTER CORING OFF
33	KILR	0-15	3	KILLER REFERENCE
34	BGPS	0-15	4	BGP START POSITION
35	BGPW	0-15	10	BGP WIDTH
36	ADCL	0-3	2	AD CLOCK DELAY
37	PWRP	0.1	0	PULSE WIDTH REFERENCE
38	YHCG	0.1	0	Y HIGH FREQ.SIGNAL CORING 1/2 GAIN
39	CKG2	0.1	1	CLOCK GENERATOR TEST BIT
40	CKGE	0.1	0	CLOCK GENERATOR TEST BIT

PJE (Projection TV Engine)

ITEM NUMBER	ADJUSTMENT ITEM	DATA RANGE	STANDARD DATA	NOTE
0	FDJS	0.1	0	SELECT REGI DATA DISPLAY OF FINE ADJ
1	OSDH	1-255	31	PJED SERVICE MENU H POSITION
2	OSDV	1-255	25	PJED SERVICE MENU V POSITION
3	FVST	0-255	25	LINE NUMBER OF FINE ADJUST START
4	V1ST	0-255	0	V1 START DATA
5	V1CU	0-255	62	V1 COUNT UP DATA
6	COHP	0-255	0	H-PHASE OF ROUGH ADJ
7	FIHP	0-255	194	H-PHASE OF FINE ADJ
8	TPHP	0-255	62	H-PHASE OF TEST PATTERN
9	DFHP	0-255	225	H-PHASE OF DYNAMIC FOCUS
10	DFHG	-128-127	-80	H-2 GAIN OF DYNAMIC FOCUS
11	DFVG	-128-127	-15	V-2 GAIN OF DYNAMIC FOCUS
12	PWM1	0-255	0	PWM1
13	PWM2	0-255	32	H-PHASE OF AUTO REGI .TEST PATTERN
14	HBLD	0-255	244	H-PHASE OF RETURNED BLUE V LINE
15	HBLW	0-63	23	PULSE WIDTH OF RETURNED BLUE V LINE
16	BLKP	0-255	27	START BLANK PULSE
17	COGV	-128-127	X(*1)	GREEN V CENT OFFSET DATA OF AUTO REGI
18	CORV	-128-127	X(*1)	RED V CENT OFFSET DATA OF AUTO REGI
19	COBV	-128-127	X(*1)	BLUE V CENT OFFSET DATA OF AUTO REGI
20	COGH	-128-127	X(*1)	GREEN H CENT OFFSET DATA OF AUTO REGI
21	CORH	-128-127	X(*1)	RED H CENT OFFSET DATA OF AUTO REGI
22	COBH	-128-127	X(*1)	BLUE H CENT OFFSET DATA OF AUTO REGI
23	SOGV	-128-127	X(*1)	GREEN V SKEW OFFSET DATA OF AUTO REGI
24	SORV	-128-127	X(*1)	RED V SKEW OFFSET DATA OF AUTO REGI
25	SOBV	-128-127	X(*1)	BLUE V SKEW OFFSET DATA OF AUTO REGI
26	SORH	-128-127	X(*1)	GREEN H SKEW OFFSET DATA OF AUTO REGI
27	SOBH	-128-127	X(*1)	RED H SKEW OFFSET DATA OF AUTO REGI
28	SOBH	-128-127	X(*1)	BLUE H SKEW OFFSET DATA OF AUTO REGI
29	ERR	FIXED	0	AUTO REGI ERROR CODE
30	ADTM	0-255	144	TIMING TO GET A/D DATA OF AUTO REGI
31	VUP	1-255	1	AUTO REGI PATTERN UPPER V POSITION
32	VMD	1-255	102	AUTO REGI PATTERN MIDDLE V POSITION
33	VLOW	1-255	212	AUTO REGI PATTERN LOWER V POSITION
34	HPR	1-510	1	AUTO REGI PATTERN H POSITION
GRN	CENT	-512-511	000/000	GREEN H/V CENT
	SKEW	-512-511	000/000	GREEN H/V SKEW
	SIZE	-512-511	-70/-190	GREEN H/V SIZE
	LIN	-512-511	xxxx / xxxx	GREEN H/V LIN
	KEY	-512-511	xxxx / xxxx	GREEN H/V KEY
BLU	PIN	-512-511	xxxx / 271	GREEN H/V PIN
	CENT	-512-511	000/000	BLUE H/V CENT
	SKEW	-512-511	080 / -130	BLUE H/V SKEW
	SIZE	-512-511	-20 / -226	BLUE H/V SIZE
	LIN	-512-511	187 / xxxx	BLUE H/V LIN
RED	KEY	-512-511	xxxx / -115	BLUE H/V KEY
	PIN	-512-511	xxxx / 198	BLUE H/V PIN
	CENT	-512-511	000/000	RED H/V CENT
	SKEW	-512-511	080 / -130	RED H/V SKEW
	SIZE	-512-511	-61 / -206	RED H/V SIZE
RED	LIN	-512-511	195 / xxxx	RED H/V LIN
	KEY	-512-511	xxxx / 124	RED H/V KEY
	PIN	-512-511	xxxx / 250	RED H/V PIN

* 1 : Set correctly by the automatic registration adjustment.
xxxx : Cannot change.

TONE (Tone Control)

ITEM NUMBER	ADJUSTMENT ITEM	DATA RANGE	STANDARD DATA	NOTE
0	RBAS	0-63	39	RESET VALUE OF USER BASS DATA
1	RTRE	0-63	35	RESET VALUE OF USER TREBLE DATA
2	BBEH	0-15	-	BBE HIGH FREQUENCY
3	BBEL	0-11	-	BBE LOW FREQUENCY
4	SUFE	7	-	SURROUND EFFECT

DSP (Digital Signal Processor)

ITEM NUMBER	ADJUSTMENT ITEM	DATA RANGE	STANDARD DATA	NOTE
0	TB0H	0-255	48	TRUSURROUND EFFECT (L+R) COARSE
1	TB0L	0-255	0	TRUSURROUND EFFECT (L+R) FINE
2	TB1H	0-255	64	TRUSURROUND EFFECT (L-R) COARSE
3	TB1L	0-255	0	TRUSURROUND EFFECT (L-R) FINE
4	TB2H	0-255	64	TRUSURROUND EFFECT (C) COARSE
5	TB2L	0-255	0	TRUSURROUND EFFECT (C) FINE
6	TBFH	0-255	165	TRUSURROUND EFFECT (S) COARSE
7	TBFL	0-255	126	TRUSURROUND EFFECT (S) FINE
8	TC0H	0-255	90	TRUSURROUND EFFECT (S) COARSE
9	TC0L	0-255	130	TRUSURROUND EFFECT (S) FINE
10	TC1H	0-255	11	TRUSURROUND EFFECT (L,R) COARSE
11	TC1L	0-255	100	TRUSURROUND EFFECT (L,R) FINE
12	SADH	0-255	64	SRS SPACE LEVEL COARSE
13	SADL	0-255	0	SRS SPACE LEVEL FINE
14	SB0H	0-255	92	SRS CENTER LEVEL COARSE
15	SB0L	0-255	0	SRS CENTER LEVEL FINE

MC (Main Chroma Decoder)

ITEM NUMBER	ADJUSTMENT ITEM	DATA RANGE	STANDARD DATA	NOTE
0	MYDR	0-31	22	MAIN Y DRIVE
1	MSHU	0-63	31	MAIN SUB HUE
2	MSCl	0-63	31	MAIN SUB COLOR
3	MUPD	0-15	7	MAIN U PEDESTAL OFFSET
4	MVPD	0-15	7	MAIN V PEDESTAL OFFSET
5	MDLY	0-3	0	MAIN Y DELAY
6	MU2P	0-15	7	MAIN U2 PEDESTAL OFFSET
7	MV2P	0-15	7	MAIN V2 PEDESTAL OFFSET
8	MY2D	0-31	19	MAIN Y2 DRIVE
9	MU2D	0-31	11	MAIN U2 DRIVE
10	MV2D	0-31	11	MAIN V2 DRIVE
11	MPRE	0-3	3	MAIN PRE-OVER

SC (Sub Chroma Decoder)

ITEM NUMBER	ADJUSTMENT ITEM	DATA RANGE	STANDARD DATA	NOTE
0	SYDR	0-31	28	SUB Y DRIVE
1	SSHU	0-63	31	SUB SUB HUE
2	SSCL	0-63	31	SUB SUB COLOR
3	SUPD	0-15	7	SUB U PEDESTAL OFFSET
4	SVPD	0-15	7	SUB V PEDESTAL OFFSET
5	SDLY	0-3	0	SUB Y DELAY
6	SU2P	0-15	7	SUB U2 PEDESTAL OFFSET
7	SV2P	0-15	7	SUB V2 PEDESTAL OFFSET
8	SY2D	0-3	20	SUB Y2 DRIVE
9	SU2D	0-15	11	SUB U2 DRIVE
10	SV2D	0-15	11	SUB V2 DRIVE
11	SPRE	0-3	3	SUB PRE-OVER

IC (Inset Chroma Decoder)

ITEM NUMBER	ADJUSTMENT ITEM	DATA RANGE	STANDARD DATA	NOTE
0	PCDR	0-15	7	PIP COLOR
1	PHDR	0-15	7	PIP HUE
2	PAFC	0-3	2	PIP AFC LOOP GAIN
3	PTAD	0-15	7	PIP TRAP F0 ADJUSTMENT
4	PTOT	0.1	0	PIP CHROMA TOT FILTER
5	PSCN	0-15	7	PIP SUB CONTRAST
6	PYDC	0-7	0	PIP Y DC TRAN
7	PSHP	0.1	1	PIP SHARPNESS F0
8	PMSK	0.1	0	PIP MACRO VISION MASK

PP (Picture In Picture Vseries Only)

ITEM NUMBER	ADJUSTMENT ITEM	DATA RANGE	STANDARD DATA	NOTE
0	BGHP	0-15	10	PIP H POSITION
1	BGHN	0-15	7	PIP H POSITION FOR NO SIGNAL
2	BGVP	0-15	7	PIP V POSITION
3	6BIT	0.1	1	6BIT(SMART6/SKIP6) MATRIX
4	MAHP	0-15	7	MAIN H ACQUISITION
5	MAVP	0-255	23	MAIN V ACQUISITION
6	SAHP	0-15	7	SUB H ACQUISITION
7	SAVP	0-255	23	SUB V ACQUISITION
8	DECS	0-31	18	SUB DECODER REGISTERS
9	DECM	0-31	18	MAIN DECODER REGISTERS
10	DIS	0-127	66	DISPLAY SETTING
11	BSIZ	0-15	2	BORDER SIZE
12	VPED	0-15	13	V PEDESTAL OFFSET
13	UPED	0-15	13	U PEDESTAL OFFSET

DAC (D/A Converter)

ITEM NUMBER	ADJUSTMENT ITEM	DATA RANGE	STANDARD DATA	NOTE
0	UVSH	0-63	31	YUV SUB HUE
1	UVSC	0-63	31	YUV SUB COLOR

PI (Picture In Picture S Series only)

ITEM NUMBER	ADJUSTMENT ITEM	DATA RANGE	STANDARD DATA	NOTE
0	PIPH	-	-	PIP H POSITION
1	PIPV	-	-	PIP V POSITION
2	PYSD	-	-	PIP SELECT DELAY
3	PYDL	-	-	PIP Y DELAY
4	PHDL	-	-	H-PULSE DELAY
5	PMVD	-	-	MAIN V-PULSE DELAY
6	PIVD	-	-	INSET V-PULSE DELAY
7	PCON	-	-	INSET CONTRAST
8	FRMY	-	-	FRAME Y
9	IPER	-	-	PIP PEDESTAL R-Y
10	IPFB	-	-	PIP PEDESTAL B-Y
11	PCPS	-	-	PIP CLP
12	PCPF	-	-	PIP CLP CYCLES
13	PPLL	-	-	PIP PLL TIME CONSTANT
14	PVNR	-	-	PIP VSP PULSE NOISE REDUCTION

ID (Identification)

ITEM NUMBER	ADJUSTMENT ITEM	DATA RANGE	STANDARD DATA	NOTE
0	AREA	0-3	0	AREA ID
1	SERS	0-3	0	SERIES ID
2	VCHP	0-3	0	V CHIP ID

CCD (Closed Caption Decoder)

ITEM NUMBER	ADJUSTMENT ITEM	DATA RANGE	STANDARD DATA	NOTE
0	CCHIP	0-63	39	OSD H POSI FOR INDEX & CC/XDS
1	CCHN	0-63	29	NO FUNCTION

OP (Option)

ITEM NUMBER	ADJUSTMENT ITEM	DATA RANGE	STANDARD DATA	NOTE
0	DISP	0-63	9	OSD H POSITION
1	FW1	0-7	2	FIELD1 WINDOW
2	FW2	0-7	3	FIELD2 WINDOW

3-10. REGISTRATION ADJUSTMENT (PJE)

• FUNCTION OF BUTTONS OF REMOTE COMMANDER FOR PJE MODE.

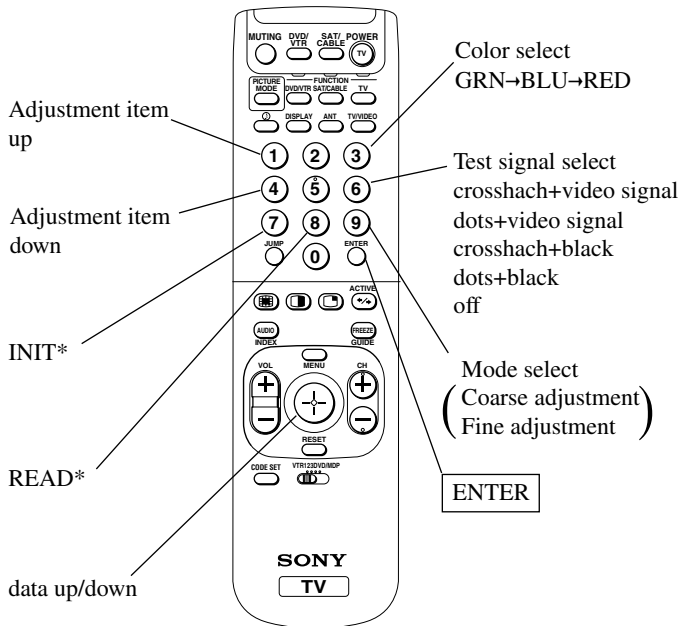

INIT*: Press 7, "INIT" green letters appear on the screen.

Then press ENTER, all the PJE data are reset.

READ*: Press 8, "READ" green letters appear on the screen.

Then press ENTER, all the PJE default data are restored.

Note: Internal patterns are used for geometry and convergence adjustments. However, sizing and centering must be done with the use of an external generator. The recommended pattern would be a monoscope, or equivalent pattern, which would provide the means to adjust both the linearity and sizing of the picture.

[SETUP FOR ADJUSTMENT]

- Current flow in circuit should be stable before attempting adjustment. So wait 5 minutes after turning on the TV power.
- At the 4 insides of the screen, locate the middle. Use a tape measure to identify the middle.

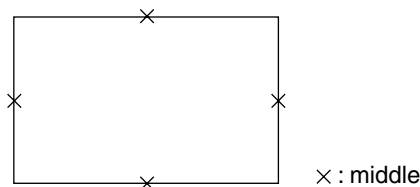

1. Set to the service mode by pressing quickly keys on the remote commander in the standby mode in the following order:

[DISPLAY] → [5] → [VOL+] → [TV POWER]

2. Change TV mode to the video input mode.
3. Change the VPNT mode to the PJE 00 FDIS.

PJE	00	00
FDIS		

4. Set FDIS data to "01" to display the registration data of each spot in the fine adjustment.

PJE	00	01
FDIS		

5. Press [6] to display the test signal (crosshatch) on the screen.
6. Select GRN CENT(*) with the [1] and [4] keys on the remote commander and check that the adjustment data is now "000" both vertically and horizontally.

	(H)	(V)
GRN	000	000
CENT		

*: In the factory preset, "GRN CENT" appears on the screen first. In case of other colors "RED" or "BLU", change color by every pressing [3] key.

7. Cover the both red and blue picture lenses with the lens caps to show only the green color.

SUB DEFLECTION ADJUSTMENT ITEM

Adjustment O : Yes - : No

Display	Adjustment item	Adjustment type		
		G	R	B
		H/V	H/V	H/V
CENT	CENT	O/O	O/O	O/O
SKEW	SKEW	O/O	O/O	O/O
SIZE	SIZE	-/-	O/O	O/O
LIN	LIN	-/-	O/-	O/-
KEY	KEY	-/-	-/O	-/O
PIN	PIN	-/O	-/O	-/O

[GREEN REGISTRATION ADJUSTMENT]

<GREEN CENTER>

1. Select GRN CENT [1] and [4] keys on the remote commander.
2. Adjust the center of crosshatch line goes the middle vertically and horizontally (GRN CENT) with the joystick on the remote commander.

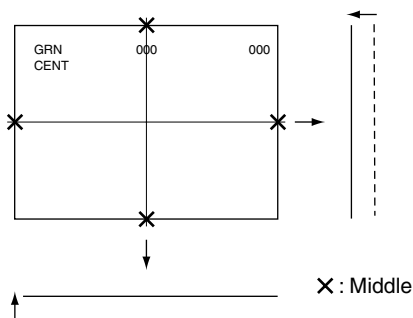

<GREEN SKEW>

1. Select GRN SKEW with the [1] and [4] keys on the remote commander.
2. Adjust the crosshatch line goes straight vertically and horizontally with the joystick on the remote commander.

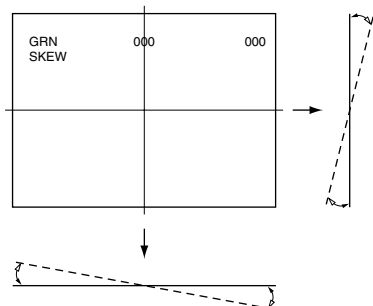

<GREEN PINCUSHION>

1. Select GRN PIN with the [1] and [4] keys on the remote commander.
2. Adjust the crosshatch line goes straight horizontally with the joystick on the remote commander.

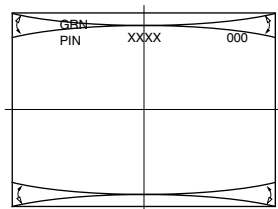

Note : These are required when either severe miss-adjustment or data loss occurred.

<FINE ADJUSTMENT>

1. Press [9] key on the remote commander to shift to the fine adjustment mode.
 The green cursor (in the GRN mode) appears on the center of the screen.
2. Use the [1] and [4] keys or the joystick on the remote commander, move the cursor (see below) everywhere you want to adjust and adjust with the joystick keys on the remote commander.

Marker movement by the [1] and [4] keys:

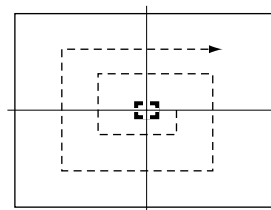

Press once the joystick the cursor turns green to white. Then you can move the cursor up and down left and right everywhere you want.

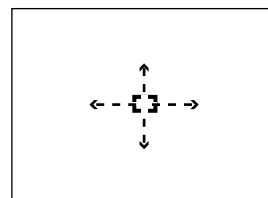

Press once the joystick the cursor stops and returns green, you can adjust around the cursor.

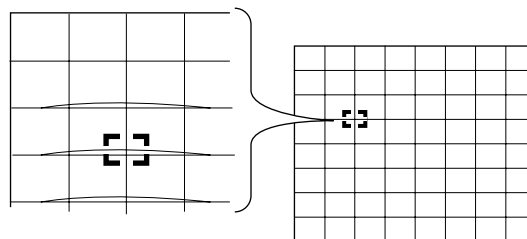

3. Press [9] key on the remote commander to shift to the coarse adjustment mode.

[RED REGISTRATION ADJUSTMENT]

<RED CENTER, SKEW>

1. Cover the blue picture lens with the lens cap to show the green and red colors.
2. Press **[3]** key on the remote commander to shift the GRN mode to the RED mode.
3. Select RED CENT or RED SKEW with the **[1]** and **[4]** keys on the remote commander and adjust while tracking each other alternately.
4. Adjust the red crosshatch lines go straight vertically and horizontally and overlaps the green lines with the joystick on the remote commander.

<RED SIZE, LINEARITY>

1. Select RED SIZE (vertically and horizontally) or RED LIN (vertically) with the **[1]** and **[4]** keys on the remote commander and adjust while tracking each other alternately.
2. Adjust the red crosshatch lines go straight vertically and horizontally and overlaps the green lines with the joystick on the remote commander.

<RED KEY, PINCUSHION>

1. Select RED KEY or PINCUSHION with the **[1]** and **[4]** keys on the remote commander and adjust while tracking each other alternately.
2. Adjust the red crosshatch lines go straight horizontally and overlaps the green lines with the joystick on the remote commander.

Note : These are required when either severe miss-adjustment or data loss occurred.

<FINE ADJUSTMENT>

1. Press **[9]** key on the remote commander to shift to the fine adjustment mode.
The red cursor (in the RED mode) appears on the center of the screen.
2. Use the **[1]** and **[4]** keys or the joystick on the remote commander, move the cursor everywhere you want to adjust and adjust with the joystick on the remote commander.

[BLUE REGISTRATION ADJUSTMENT]

1. Remove the lens cap from the blue picture lens to show full color.
2. Press **[3]** key on the remote commander to shift the RED mode to the BLU mode.
3. Adjust BLU CENT, BLU SKEW, BLU SIZE, BLU LIN, BLU KEY and BLU PIN in the same procedure of the red registration adjustment.

[FINAL CHECK]

1. Store the new adjustment (offset) value on the remote control by pressing **[MUTING]** and **[ENTER]**.
2. Press the FLASH FOCUS button on the front panel.
(The Offset value is now automatically stored.)
3. Check that no error message appears.
If an error message appears, recheck.

Note: In case of replacing CRTs, adjust the set-up adjustments (items 3-1 to 3-8) and the registration adjustment (item 3-10).
In case of replacing two or three CRTs at the same time, replace and adjust one by one.

3-11. AUTO REGISTRATION ERROR CODE LIST

If an error code is displayed after the set has been fully adjusted, correctly, please check the following items: position, tilt and sizing. If either of these adjustments are off, even slightly, the auto-registration pattern will not hit the four sensors properly. This occurs when the internal generator patterns is being flashed on the screen for the sensors to read. Therefore, auto registration (called auto-focus) cannot operate properly causing an error code to be displayed. In order for this function to operate properly, correct position, tilt and size must be adjusted properly.

[ERROR CODE LIST]

ERROR CODE	DISCRIPTION	NOTE
00	No Error	
10	Sensor Output Level Low	* Check wiring, beam position, sensor. 0 : Upper Center 1 : Middle Left 2 : Middle Right 3 : Lower Center
20	Sensor Output Level High	* Check OP-amp circuit. 0 : Upper Center 1 : Middle Left 2 : Middle Right 3 : Lower Center
30	Adjustment Loop Counter Overflow	* Check the registring information on the convergence board.
40	Regi Data Overflow	* Check the convergence yoke driver ICs. * Convergence patterns displayed are out of normal range.
50	Regi Data Overflow	
60	Offset Overflow	
70	Offset Overflow	

* In case of multiple error, last error is displayed.

• ERROR CODE SCREEN DISPLAY

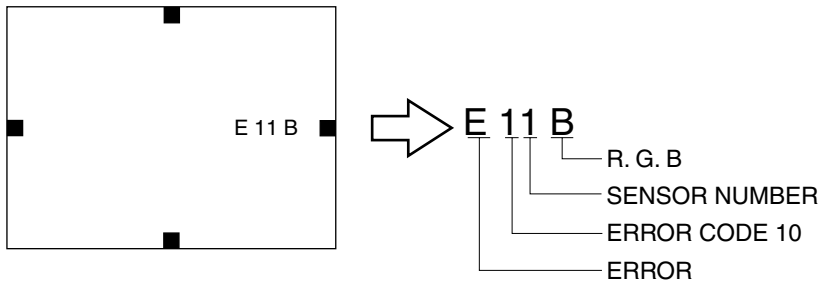

[SENSOR POSITION]

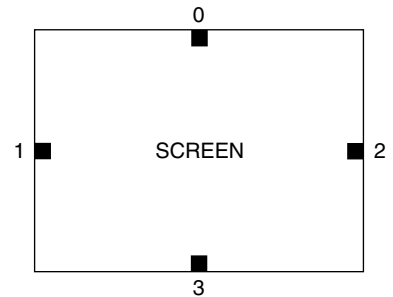

- 0 : UPPER SENSOR
- 1 : LEFT SENSOR
- 2 : RIGHT SENSOR
- 3 : LOWER SENSOR

* Error code will be displayed on center of screen for 3 seconds.

• ERROR CODE DISPLAY IN REGI SERVICE MODE

